



1-OF-10 DECODER/DRIVER OPEN-COLLECTOR

The SN54/74LS145, 1-of-10 Decoder/Driver, is designed to accept BCD inputs and provide appropriate outputs to drive 10-digit incandescent displays. All outputs remain off for all invalid binary input conditions. It is designed for use as indicator/relay drivers or as an open-collector logic circuit driver. Each of the high breakdown output transistors will sink up to 80 mA of current. Typical power dissipation is 35 mW. This device is fully compatible with all TTL families.

- Low Power Version of 54/74145
- Input Clamp Diodes Limit High Speed Termination Effects

CONNECTION DIAGRAM DIP (TOP VIEW)

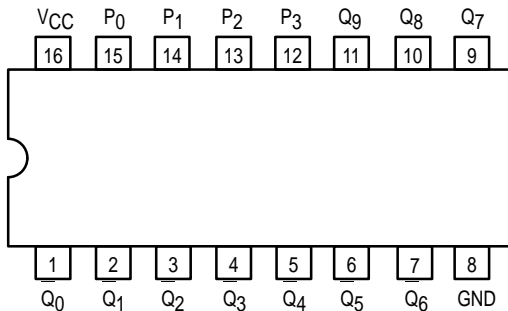

PIN NAMES

P_0, P_1, P_2, P_3 BCD Inputs
 Q_0 to Q_9 Outputs (Note b)

LOADING (Note a)

LOADING (Note a)	
HIGH	LOW
0.5 U.L.	0.25 U.L.
Open Collector	15 (7.5) U.L.

NOTES:

- a) 1 TTL Unit Load (U.L.) = 40 μ A HIGH/1.6 mA LOW.
b) The Output LOW drive factor is 2.5 U.L. for Military (54) and 15 U.L. for Commercial (74) Temperature Ranges.

LOGIC DIAGRAM

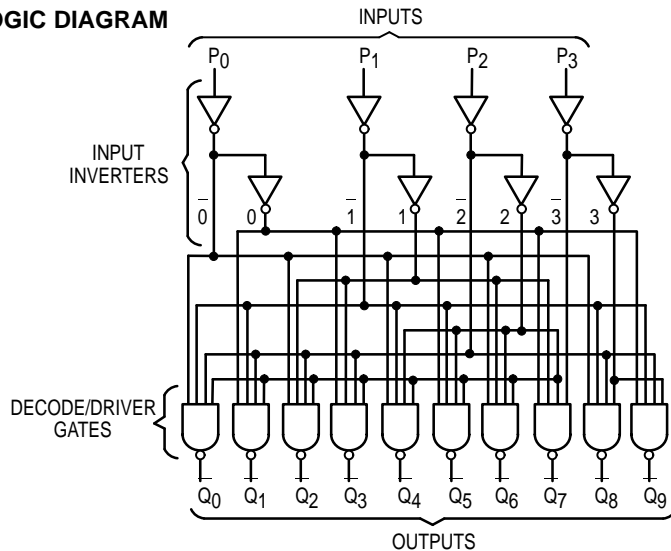

SN54/74LS145

1-OF-10 DECODER/DRIVER OPEN-COLLECTOR LOW POWER SCHOTTKY

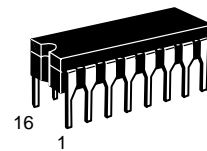

J SUFFIX
CERAMIC
CASE 620-09

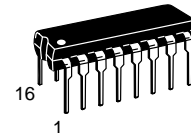

N SUFFIX
PLASTIC
CASE 648-08

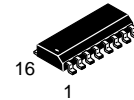

D SUFFIX
SOIC
CASE 751B-03

ORDERING INFORMATION

SN54LSXXXJ Ceramic
SN74LSXXXN Plastic
SN74LSXXXD SOIC

LOGIC SYMBOL

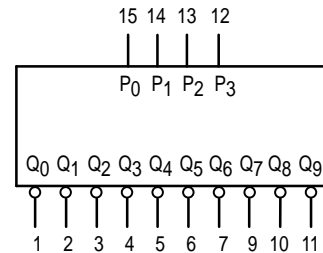

V_{CC} = PIN 16
GND = PIN 8

SN54/74LS145

TRUTH TABLE

INPUTS				OUTPUTS									
P ₃	P ₂	P ₁	P ₀	Q ₀	Q ₁	Q ₂	Q ₃	Q ₄	Q ₅	Q ₆	Q ₇	Q ₈	Q ₉
L	L	L	L	L	H	H	H	H	H	H	H	H	H
L	L	L	H	H	L	H	H	H	H	H	H	H	H
L	L	H	L	H	H	L	H	H	H	H	H	H	H
L	L	H	H	H	H	H	L	H	H	H	H	H	H
L	H	L	L	H	H	H	H	L	H	H	H	H	H
L	H	L	H	H	H	H	H	H	L	H	H	H	H
L	H	H	L	H	H	H	H	H	H	L	H	H	H
L	H	H	H	H	H	H	H	H	H	H	L	H	H
H	L	L	L	H	H	H	H	H	H	H	H	L	H
H	L	L	H	H	H	H	H	H	H	H	H	H	L
H	L	H	L	H	H	H	H	H	H	H	H	H	H
H	L	H	H	H	H	H	H	H	H	H	H	H	H
H	H	L	L	H	H	H	H	H	H	H	H	H	H
H	H	L	H	H	H	H	H	H	H	H	H	H	H
H	H	H	L	H	H	H	H	H	H	H	H	H	H
H	H	H	H	H	H	H	H	H	H	H	H	H	H

H = HIGH Voltage Level
L = LOW Voltage Level

GUARANTEED OPERATING RANGES

Symbol	Parameter		Min	Typ	Max	Unit
V _{CC}	Supply Voltage	54	4.5	5.0	5.5	V
		74	4.75	5.0	5.25	
T _A	Operating Ambient Temperature Range	54	-55	25	125	°C
		74	0	25	70	
V _{OH}	Output Voltage — High	54, 74			15	V
I _{OL}	Output Current — Low	54			12	mA
		74			24	

SN54/74LS145

DC CHARACTERISTICS OVER OPERATING TEMPERATURE RANGE (unless otherwise specified)

Symbol	Parameter	Limits			Unit	Test Conditions
		Min	Typ	Max		
V_{IH}	Input HIGH Voltage	2.0			V	Guaranteed Input HIGH Voltage for All Inputs
V_{IL}	Input LOW Voltage	54		0.7	V	Guaranteed Input LOW Voltage for All Inputs
		74		0.8		
V_{IK}	Input Clamp Diode Voltage		-0.65	-1.5	V	$V_{CC} = \text{MIN}$, $I_{IN} = -18 \text{ mA}$
I_{OH}	Output HIGH Current	54, 74		250	μA	$V_{CC} = \text{MIN}$, $V_{OH} = \text{MAX}$
V_{OL}	Output LOW Voltage	54, 74	0.25	0.4	V	$V_{CC} = V_{CC} \text{ MIN}$, $V_{IN} = V_{IL} \text{ or } V_{IH}$ per Truth Table
		74	0.35	0.5	V	
		54, 74	2.3	3.0	V	
I_{IH}	Input HIGH Current			20	μA	$V_{CC} = \text{MAX}$, $V_{IN} = 2.7 \text{ V}$
				0.1	mA	$V_{CC} = \text{MAX}$, $V_{IN} = 7.0 \text{ V}$
I_{IL}	Input LOW Current			-0.4	mA	$V_{CC} = \text{MAX}$, $V_{IN} = 0.4 \text{ V}$
I_{CC}	Power Supply Current			13	mA	$V_{CC} = \text{MAX}$, $V_{IN} = \text{GND}$

AC CHARACTERISTICS ($T_A = 25^\circ\text{C}$)

Symbol	Parameter	Limits			Unit	Test Conditions
		Min	Typ	Max		
t_{PHL} t_{PLH}	Propagation Delay P_n Input to Q_n Output			50 50	ns	$V_{CC} = 5.0 \text{ V}$ $C_L = 45 \text{ pF}$

AC WAVEFORMS

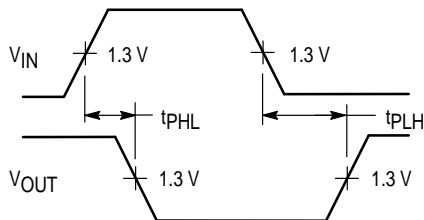

Figure 1

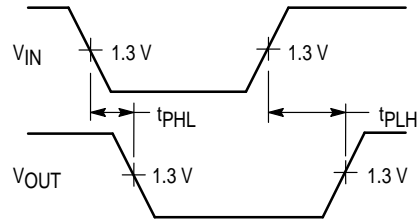

Figure 2